

JHD40BT

JHD40BT/JHD40BTBRP/434-1228-01

Installation and Operation Manual

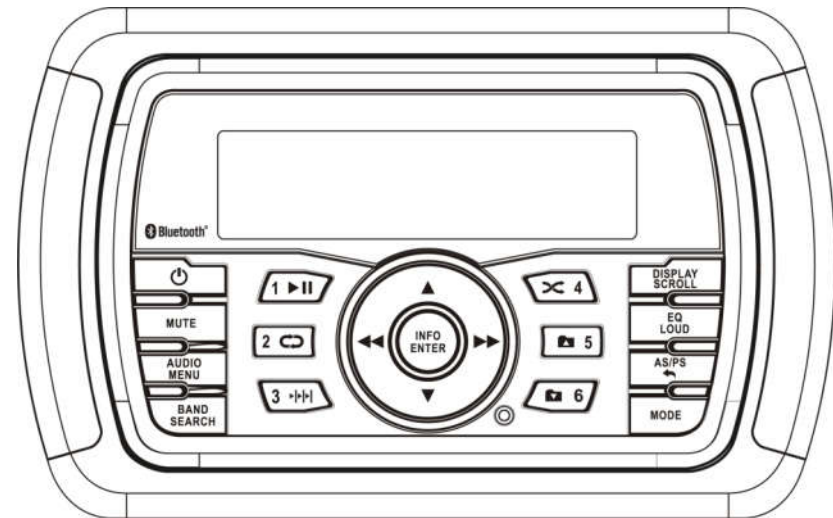
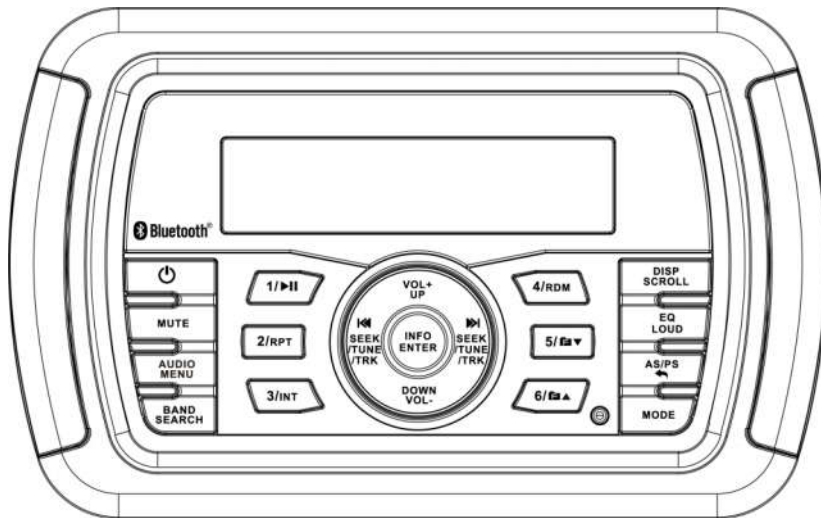

CONTENTS

| | |
|-------------------------------|----|
| Warnings and Compliance | 1 |
| Introduction..... | 2 |
| Installation | 3 |
| Wiring..... | 4 |
| Basic Operation | 5 |
| Tuner Operation..... | 7 |
| Weather Band Operation | 8 |
| MP3/WMA Operation | 9 |
| iPod Operation..... | 11 |
| Bluetooth Operation..... | 12 |
| Care and Maintenance | 14 |
| Troubleshooting | 14 |
| Specifications | 15 |

Copyrights and Trademarks

iPhone, iPod, iPod Classic, iPod Shuffle and iPod Touch are trademarks of Apple Inc., registered in the U.S. and other countries.

WARNINGS AND COMPLIANCE

Important Safety Instructions

NOTE: Keep the volume level low enough to be aware of your surroundings.

NOTE: USE THE PROPER POWER SUPPLY! This product is designed to operate with a 12 volt DC negative ground battery system.

FCC Notes

WARNING! Changes or modifications to this unit not expressly approved by the party responsible for compliance could void the user's authority to operate the equipment.

NOTE: This equipment has been tested and found to comply with the limits for a Class B digital device, pursuant to Part 15 of the FCC Rules. These limits are designed to provide reasonable protection against harmful interference in a residential installation.

This equipment generates, uses, and can radiate radio frequency energy and, if not installed and used in accordance with the instructions, may cause harmful interference to radio communications.

However, there is no guarantee that interference will not occur in a particular installation. If this equipment does cause harmful interference to radio or television reception, which can be determined by turning the equipment off and on, the user is encouraged to try to correct the interference by one or more of the following measures:

- Reorient or relocate the receiving antenna.
- Increase the separation between the equipment and receiver.
- Connect the equipment into an outlet on a circuit different from that to which the receiver is connected.
- Consult the dealer or an experienced radio/TV technician for help.

INTRODUCTION

System Features

Features of the audio system include:

- White LED Backlit LCD
- IPx6 Waterproof
- Low Battery Alarm
- AM/FM WORLD Tuner with 30 Presets (12 AM, 18 FM)
- Weatherband with Weather Alert
- Bluetooth (Supports A2DP and AVRCP)
- USB Playback of MP3/WMA Files
- Made for iPod/iPhone (USB Input)
- Mute
- Pre-set Equalizer - 5 settings (User > Flat > Pop > Classical > Rock)
- Electronic Bass, Treble, Balance and Fader Controls
- Output Power 22W x 4
- Wired Remote Control Ready (JHDHBC)
- 2-Channel Pre-amp Line Level Outputs
- Auxiliary Audio Input (Rear RCA)

Content List

- Radio
- Installation Opening Cutout Template
- M4 x 0.7 Screws (x4)

INSTALLATION

Before you Begin

Before you begin, always disconnect the battery negative terminal.

Important Notes

- Before final installation, test the wiring connections to make sure the unit is connected properly and the system works.
- Consult with your nearest dealer if installation requires the drilling of holes or other modifications to your vehicle.
- Install the unit where it does not interfere with driving and cannot injure passengers if there is a sudden or emergency stop.

Front Mount

1. Use the following template to cut the installation opening:

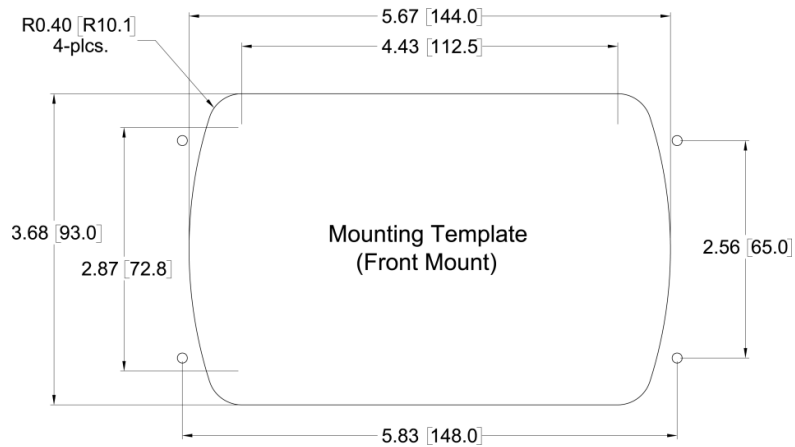

2. Check the dashboard opening size by sliding the radio into it. If the opening is not large enough, carefully cut or file as necessary until the radio slides into the opening. Check that there will be sufficient space behind the dashboard for the radio chassis.
3. Place the radio in front of the dashboard opening so the wiring can be brought through the opening.
4. Follow the wiring diagram carefully and make certain all connections are secure to ensure proper operation.
5. After completing the wiring connections, turn the unit on to confirm operation (vehicle accessory switch must be on). If the unit does not operate, recheck all wiring until the problem is corrected. Once proper operation is achieved, turn the accessory switch off and proceed with final mounting of the chassis.

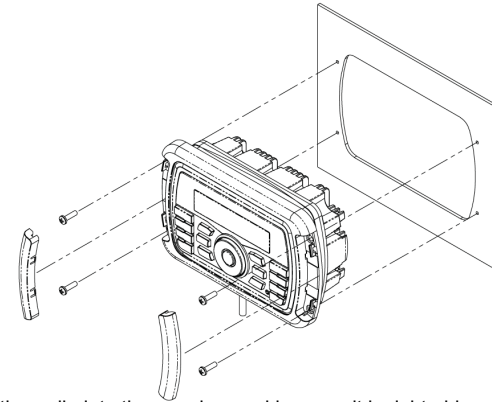

6. Carefully slide the radio into the opening, making sure it is right-side-up.
7. Secure the radio to the dashboard using #6 panhead screws (not provided).
8. Replace the covers on either side of the radio.
9. Test radio operation by referring to the operating instructions for the unit.

Removing the Unit

To remove the radio after front mount installation, remove the covers, unscrew the installation screws and pull the radio out.

Reconnect Battery

When wiring is complete, reconnect the battery negative terminal.

Bracket Mount

The VOSHD4MNT (sold separately) is a versatile mounting base/bracket for easy installation on most flat surfaces. Please use the included M4 screws to attach the radio to the bracket, as shown in the diagram below.

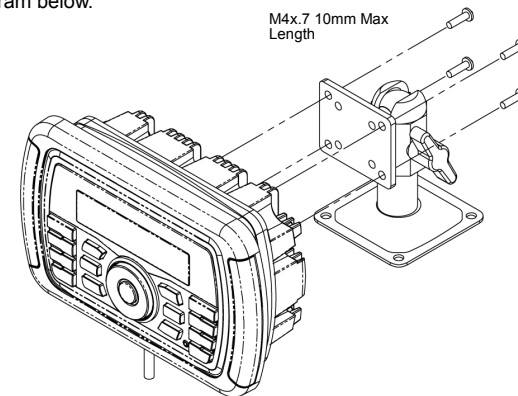

NOTE: Use only the M4 x 7-10mm length screws, included.

WIRING

| WIRE COLOR | DESCRIPTION |
|--------------|-------------------------|
| GREEN | LEFT REAR SPEAKER (+) |
| WHITE | LEFT FRONT SPEAKER (+) |
| GRAY | RIGHT FRONT SPEAKER (+) |
| VIOLET | RIGHT REAR SPEAKER (+) |
| GREEN/BLACK | LEFT REAR SPEAKER (-) |
| WHITE/BLACK | LEFT FRONT SPEAKER (-) |
| GRAY/BLACK | RIGHT FRONT SPEAKER (-) |
| VIOLET/BLACK | RIGHT REAR SPEAKER (-) |
| BLUE | AMPLIFIER REMOTE |
| BLACK | GROUND |
| RED | +12V SWITCHED |

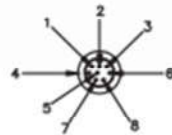

VIEW A-A
WIRE INSERTION VIEW

| PIN NO. | DESCRIPTION |
|---------|-------------|
| 1 | VOLUME + |
| 2 | VOLUME - |
| 3 | MUTE |
| 4 | GROUND |
| 5 | TUNE + |
| 6 | TUNE - |
| 7 | MODE |
| 8 | GROUND |

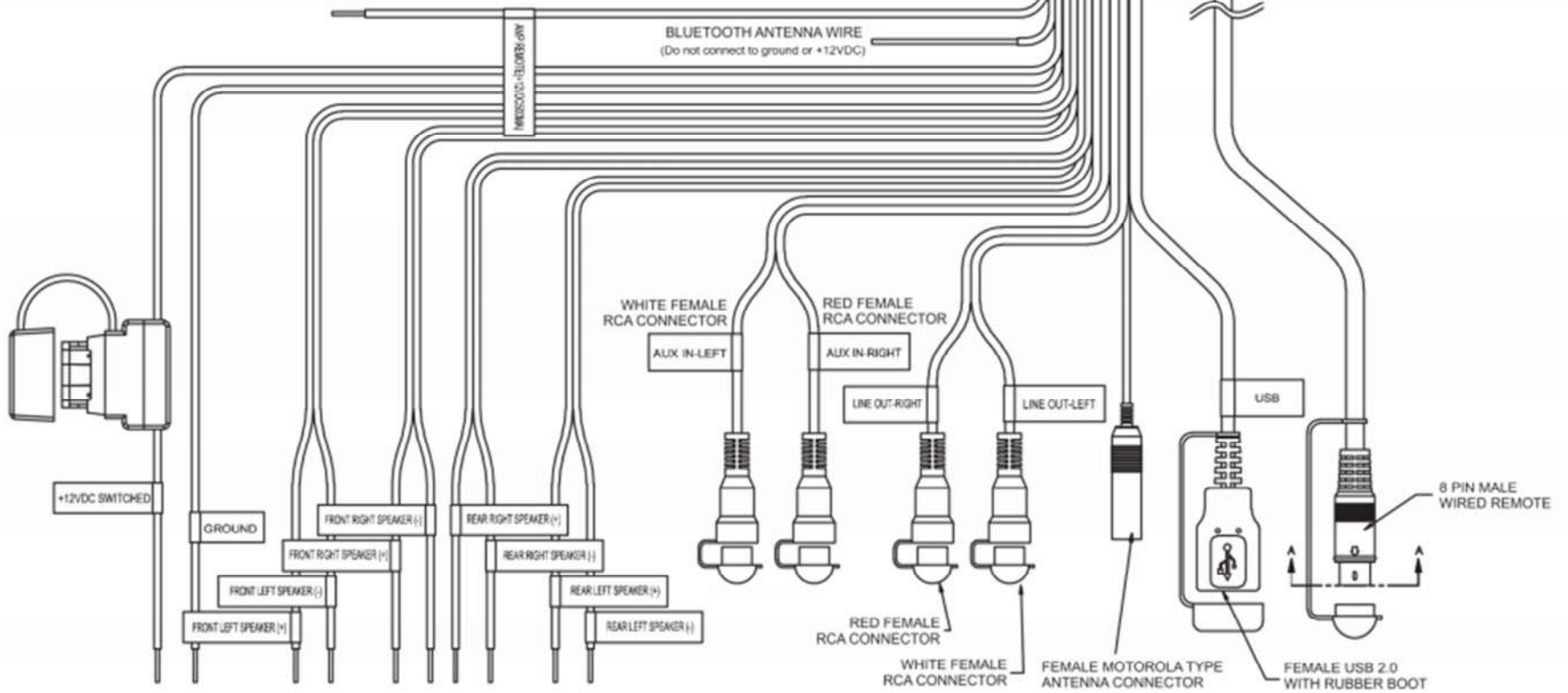
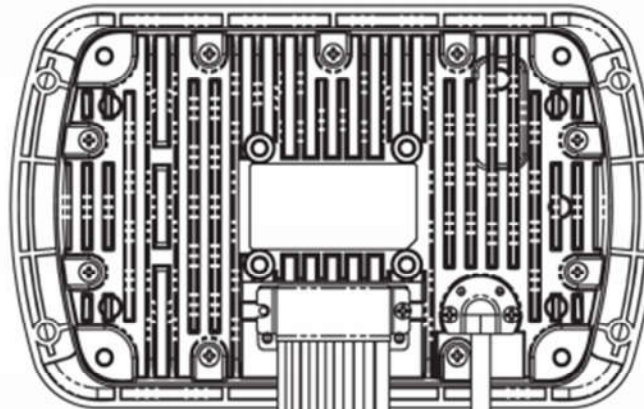

BASIC OPERATION

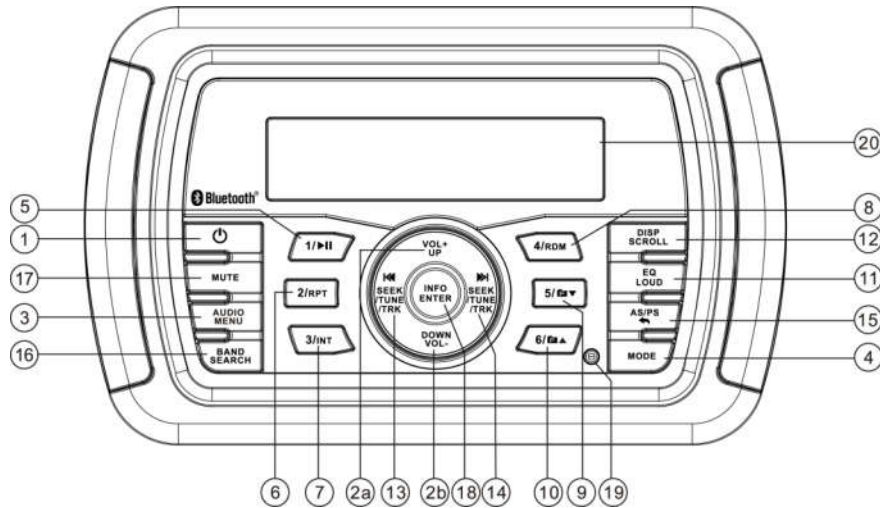

NOTE: The key pad may vary slightly in shape depending on the model and revision

Power On/Off

Press the power button (1) on the front panel to turn the unit on or off.

Volume Control

To increase the volume, press the **VOL+ UP / ▲** button (2a). To decrease the volume, press the **DOWN VOL- / ▼** button (2b).

Mute

Press the **MUTE** button (17) on the control panel to mute the audio output. Press **MUTE** again to restore the audio output to the previous level.

Mode

Press the **MODE** button (4) on the control panel to select a different mode of operation, as indicated on the display panel. Available modes include AM/FM Tuner, Weatherband, iPod, USB, AUX In (optional Auxiliary Input), and BT Audio.

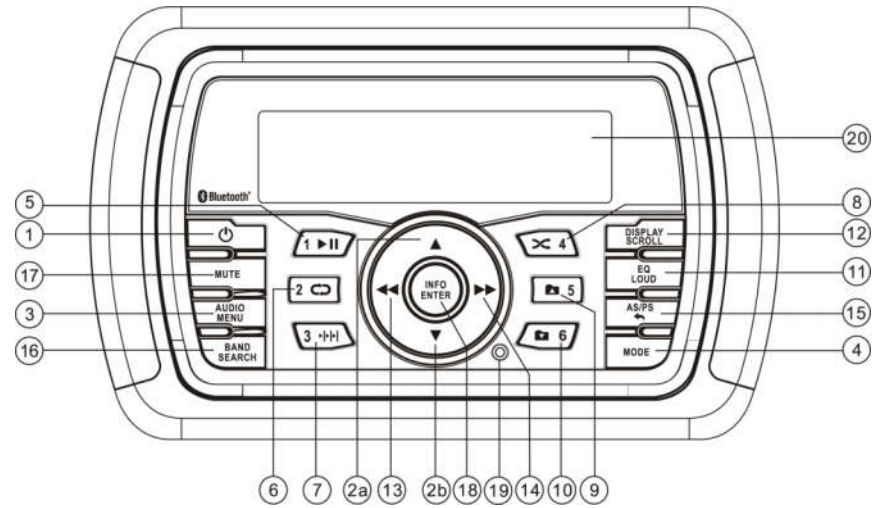

Reset

The reset button should be activated for the following reasons:

- initial installation of the unit when all wiring is completed
- function buttons do not operate
- error symbol on the display

Use a ball point pen or similar object to press the **RESET** button (19). This may be necessary should the unit display an error code.

You can recover factory default settings using the RESET function located on the system menu. With "RESET To Defaults?", press the **INFO/ENTER** button (18) to activate.

NOTE: The reset button may vary in location depending on the model and revision

Audio Menu

Press the **AUDIO/MENU** button (3) on the control panel to access the audio menu. You can navigate through the audio menu items by pressing the **AUDIO/MENU** button repeatedly. Once the desired menu item appears on the display, adjust that option by pressing the **VOL+ UP / ▲** or **DOWN VOL- / ▼** buttons (2) within 5 seconds. The unit will automatically exit the audio menu after five seconds of inactivity. The following menu items can be adjusted.

Bass

Use the **VOL+ UP / ▲** or **DOWN VOL- / ▼** buttons to adjust the bass level range from “-6” to “+6”.

Treble

Use the **VOL+ UP / ▲** or **DOWN VOL- / ▼** buttons to adjust the treble level range from “-6” to “+6”.

Balance

Use the **VOL+ UP / ▲** or **DOWN VOL- / ▼** buttons to adjust the balance between the left and right speakers from “L12” (full left) to “R12” (full right).

Fade

Use the **VOL+ UP / ▲** or **DOWN VOL- / ▼** buttons to adjust the fader between the rear and front speakers from “R12” (full rear) to “F12” (full front).

System Menu

1. Press and hold the **AUDIO/MENU** button (3) for more than 2 seconds to enter the system menu.
2. Press the **VOL+ UP / ▲** or **DOWN VOL- / ▼** buttons (2) repeatedly to navigate the system menu and select the desired item.
3. Press the **INFO/ENTER** button (18) or **◀SEEK/TUNE/TRK /** or **▶SEEK/TUNE/TRK /** buttons (13, 14) to adjust the selected menu item.
4. Press the **AS/PS** button (15) to return to the previous operation.

The following items can be adjusted:

- Key Beep (On/Off): Turn the audible beep On/Off (heard when functions/buttons are selected). NOTE: Beep tone off will not affect Battery Alarm audible tone.
- LCD Backlight (1/10 – 10/10): Adjust LCD brightness.
- LCD Contrast (1/10 – 10/10): Set LCD contrast.
- Tuning Region (USA/Europe/China/Latin/Australia/Russia/Japan): Set frequency spacing for various regions.
- Weather Alert Configure: Press the **INFO/ENTER** button (18) to see weather alert options.
 - Weather Alert (On/Off): Determines if the weather band alert feature is activated.
 - Alert Volume (1/40 – 40/40): Set default volume for weather alert broadcasts.
- Battery Alarm (On/Off): Monitor voltage on ACC line and send alert when voltage is low.
- Battery Auto-Off (On/Off): Automatically turn off power to radio when battery voltage is low.
- Bluetooth Device (Lock/Unlock, Disconnect/Connect, Delete): View, lock and delete from a list of previously paired mobile phone device models.
- Bluetooth Pair <ENTER>: Choose **INFO/ENTER** to automatically pair a device.
- Bluetooth (On/Off): Choose “Bluetooth On” or “Bluetooth Off”.
- Volume Preset (1/40 – 40/40): Select an automatic turn-on volume.
- Reset to Defaults <ENTER>: Return the EEPROM to factory default set up values. Press the **INFO/ENTER** button (18) to select.

NOTE: Bluetooth Pair and Bluetooth Device menu options are only available while the Bluetooth feature is ON and the radio is in Bluetooth Audio mode.

NOTE: A locked Bluetooth device will not be overwritten from the list.

Battery Alarm Operation

If Battery Alarm is set to “On”, an alarm will sound (8 beeps every 30 sec) when the voltage drops to 10.5V (+/- 0.3V). A visual warning (Low Battery) will appear flashing (8 flashes every 30 sec) in the LCD display.

NOTE: “Off” is the default setting for Battery Alarm. If the audio is muted or the volume is set to 0, the audible beep will not be heard.

Equalizer

Press the **EQ/LOUD** button (11) to turn on the equalization function and select between five pre-defined bass and treble curves: User > Flat > Pop > Classical > Rock.

Loudness

Press and hold the **EQ/LOUD** button (11) to toggle true loudness on/off. When listening to music at low volumes, this feature will boost the bass ranges to compensate for the characteristics of human hearing.

Auxiliary Input

To access an auxiliary device:

1. Connect the portable audio player to the AUX IN cables routed from the rear of the radio.
2. Press the **MODE** button (4) to select Aux In mode.
3. Press **MODE** again to cancel Aux In mode and switch to the next mode.

Liquid Crystal Display (LCD)

The current frequency and activated functions are shown on the LCD panel (20).

NOTE: LCD panels may take longer to respond when subjected to cold temperatures for an extended period of time. In addition, the visibility of the numbers on the LCD may decrease slightly. The LCD display will return to normal when the temperature increases to a normal range.

Quick Exit Hot Key

In the following modes and conditions, press the **AS/PS** button (15) < 3 seconds to quickly exit the current operation without waiting for the system default time out:

- System menu operation
- Searching mode
- Audio menu operation

TUNER OPERATION

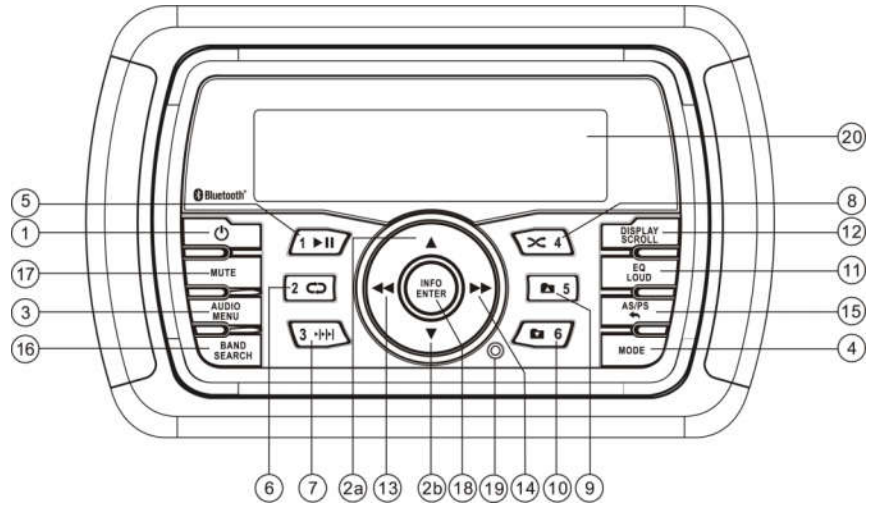
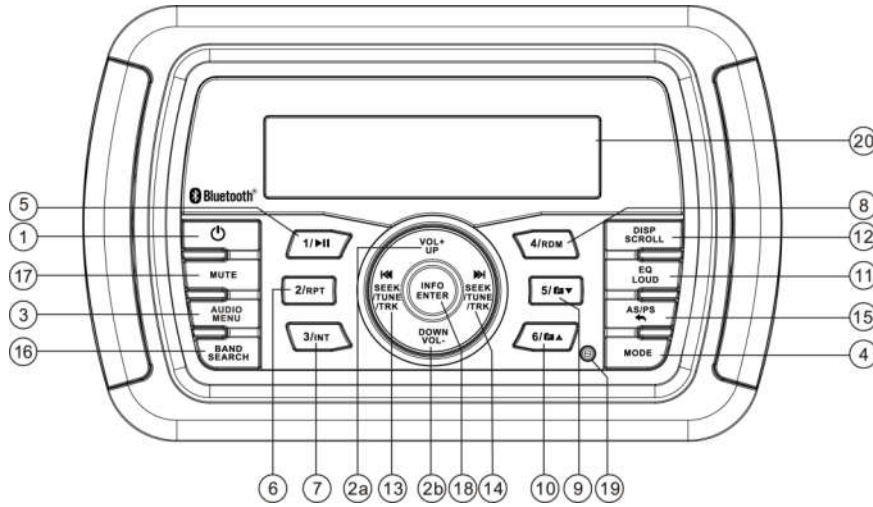

NOTE: The key pad may vary slightly in shape depending on the model and revision

Select a Band

Press the **BAND/SEARCH** button (16) to change between three FM bands and two AM (MW) bands.

Manual Tuning

Press the **SEEK/TUNE/TRK** / **SEEK/TUNE/TRK** buttons (13, 14) to seek stations up/down step by step.

Auto Seek Tuning

Press and hold the **SEEK/TUNE/TRK** / **SEEK/TUNE/TRK** buttons (13, 14) to automatically seek the next or previous strong station.

Preset Stations

Six numbered preset buttons store and recall stations for each band.

Store a Station

Select a band (if needed), then select a station. Press and hold a preset button (5-10) for two seconds. The preset number will appear in the display.

Recall a Station

Select a band (if needed). Press a preset button (5-10) to select the corresponding stored station.

Automatically Store / Preset Scan (AS/PS)

Automatically Store

Select an AM or FM band. Press and hold the **AS/PS** button (15) for more than three seconds to automatically select strong stations and store them in all bands. The new stations replace any stations already stored in that band.

NOTE: During Auto Store (AS), the tuner will default to "Local" mode while scanning the band initially. After scanning the entire band once, the unit will switch to "Distant" mode for all subsequent Auto Store tuning.

Preset Scan

Select a band (if needed). Press the **AS/PS** button (15) to scan stations stored in all bands. The unit will pause for ten seconds at each preset station. Press **AS/PS** again to stop scanning when the desired station is reached.

WEATHER BAND OPERATION

Accessing the Weather Band

Press the **MODE** button (4) to access the weather band mode.

What is the NOAA Weather Radio?

NOAA is a nationwide system that broadcasts local weather emergency information 24 hours a day. The U.S. network has more than 530 stations covering the 50 states, as well as the adjacent coastal waters, Puerto Rico, the U.S. Virgin Islands and the U.S. Pacific Territories. Each local area has its own transmitting station and there are a total of seven broadcasting frequencies used: 162.400MHz (CH2), 162.425MHz (CH4), 162.450MHz (CH5), 162.475MHz (CH3), 162.500MHz (CH6), 162.525MHz (CH7) and 162.550MHz (CH1).

How many stations can I expect to receive?

Since the broadcasts pertain to local weather and information, the transmission power is usually very low (much less than AM or FM stations) which means you will usually receive only one station unless you are on the edge of two or more broadcast signals. The most you will receive is two or three, and that is rare.

Is it possible I won't receive any stations?

Depending on location, it's possible to receive a very weak signal or none at all. Also, similar to AM and FM signals, weather band signals are subject to surrounding conditions, weather, obstructions of the signal by hills or mountains, etc. If no NOAA signals are found/received, the tuner will scan all seven NOAA frequencies every 30 seconds.

How will I know I am tuned to the weather band?

When you select the weather band, the "WB" icon will appear on the display panel, along with the current channel indication. Press the **◀SEEK/TUNE/TRK /** or **▶SEEK/TUNE/TRK /** buttons (13, 14) to tune to each of the seven channels until you find the weather band station broadcasting in your area.

NOAA Weather Alert

The Weather Alert function adds an additional level of user safety by automatically switching from the current function mode to weather band mode for a minimum of 60 seconds if a NOAA warning tone (1050 Hz) is received/detected. If no additional warning tone is received for 60 seconds, the unit will switch back to the last known function mode.

The Weather Alert function can be turned "on" or "off" by the Audio/Menu key, as described on page five. When "ON", the weather tuner remains active, even when the radio is turned off (as long as the power is still applied to the radio). If a weather alert is issued, the radio will turn on and play the announcement for 120 seconds, then turn back off and revert to weather alert monitor mode.

The radio will not respond to any weather alerts when it is off and will not automatically switch to the weather band if an alert is issued.

NOTE: If the unit is programmed for any other regions outside of US, the WB functions will be disabled.

Weatherband Frequencies

| Frequency (MHz) | Preset |
|------------------------|---------------|
| 162.400 | 2 |
| 162.425 | 4 |
| 162.450 | 5 |
| 162.475 | 3 |
| 162.500 | 6 |
| 162.525 | 7 |
| 162.550 | 1 |

MP3/WMA OPERATION

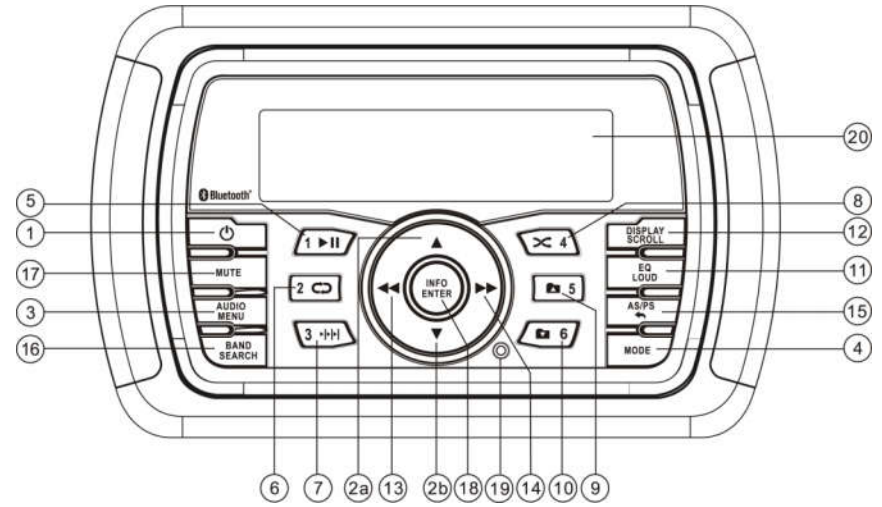
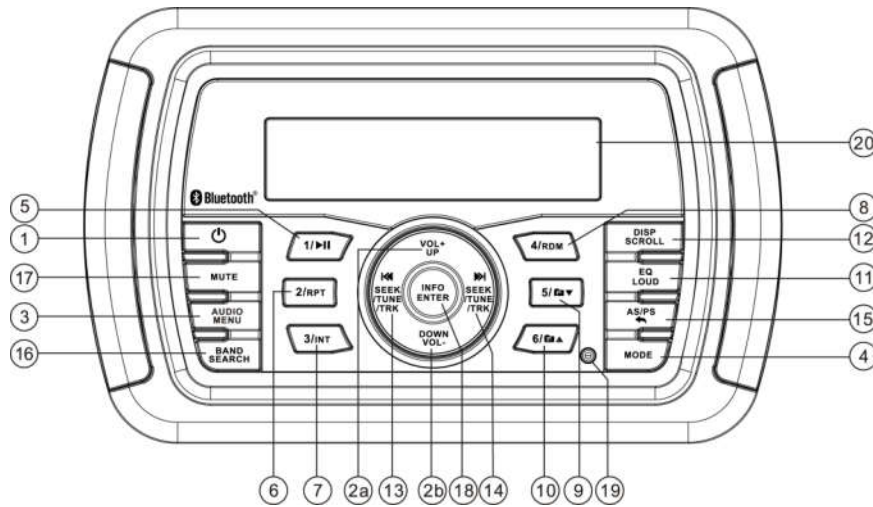

NOTE: The key pad may vary slightly in shape depending on the model and revision

MP3/WMA File Requirements

This unit can play MP3 (MPEG1, 2, 2.5 Audio Layer 2/3) and WMA (version 7/8/9).

Media Requirements

The following formats are available for the media used in this unit. The maximum number of characters used for file name including the delimiter (".") and three-character extension are indicated in parentheses.

- ISO 9660 Level 1 (11 characters)
- ISO 9660 Level 2 (31 characters)
- Joliet (31 characters)
- Romeo (31 characters)

The media reproducible on this unit has the following limitations:

- Maximum number of nested folders: 8
- Maximum number of files per device: 999
- Maximum number of folders per device: 99

Use the following settings when compressing audio data in MP3 data with the MP3 encoder.

- Transfer bit rate: 32 - 320 kbps
- Maximum file/directory name: 64 bytes

ID3 Support

This unit supports ID3 tag versions 1.0, 1.1, 2.0 and 2.3 (Max 32 bytes).

Installing a USB Device

Insert your USB drive into the USB connector routed from the rear of the radio. The unit will automatically search for MP3 and WMA files on the device and begin playback. You can access USB mode from any other mode by pressing the **MODE** button (4).

WARNING: Do not remove the USB device when **USB PLAY** mode is active. Press **MODE (4)** to change to another mode before removing the device.

Controlling Playback

Pause/Play

Press the **1 ▶||** button (5) to suspend playback. Press the **1 ▶||** button again to resume play.

Track Select

Press the **▶SEEK/TUNE/TRK / (14)** or **◀SEEK/TUNE/TRK / (13)** button for less than one second to advance to the next file, or **press and hold** to fast forward or fast reverse. Playback begins when the button is released.

Repeat (RPT)



Press the **2 RPT / (6)** button to repeatedly play the current file. Press **2 RPT / (6)** again to repeat all songs in the current folder. Press **2 RPT / (6)** a third time to resume normal playback.

Intro Scan (INT)





Press the **3 INT** /  button (7) once to play the first 10 seconds of each file in the current device.

When the desired file is reached, press **3 INT** /  again to end the scan and play the selected file.

Random (RDM)

Press the **4 RDM** /  button (8) to randomly play all files in the current folder. Press **4 RDM** /  again to resume normal playback.





Navigating Folders

Press the **5**  /  button (9) to move to the previous folder and begin playback of the first song in the folder. Press the **6**  /  button (10) to advance to the next folder and begin playback of the first song in the folder.

Alternate Display Information

Press the **DISP/SCROLL** button (12) to change the display information from file name default display to Artist/Song Title double line display mode.

MP3/WMA Directory Search

1. Press the **BAND/SEARCH** button (16) to enter directory search mode.
2. The LCD will display the folder list for the current directory. Press the **BAND/SEARCH** button to view the folder directory list.
3. Navigate the folder list by pressing the **VOL+ UP** /  or **DOWN VOL-** /  buttons (2).
4. Press the **INFO/ENTER** button to select a folder. The LCD will display the list of files within that folder.
5. Navigate the file list by pressing the **VOL+ UP** /  or **DOWN VOL-** /  buttons.
6. Press the **INFO/ENTER** button to select a file.
7. Use the **AS/PS**  button (15) to reverse navigate the list.

iPod OPERATION

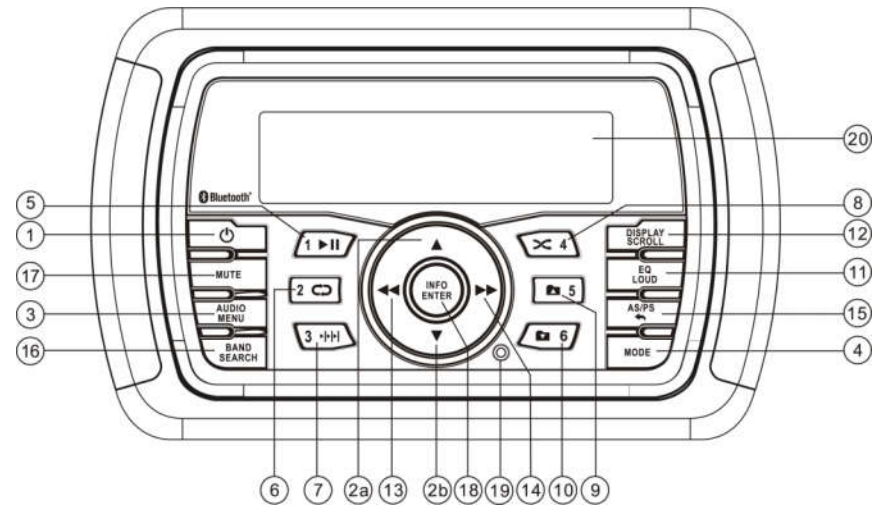
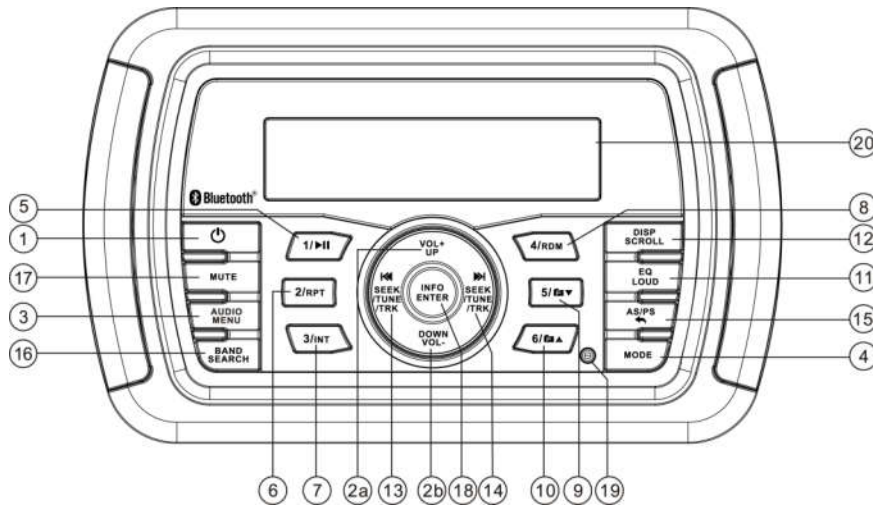

NOTE: The key pad may vary slightly in shape depending on the model and revision

This unit is equipped with an iPod ready function that will allow you to control your iPod (if compatible) using the control panel buttons. The following iPod versions are supported:

- iPod Nano 5G,
- iPod Classic
- iPhone 4, 4S
- iPod Touch 3G, 4G

NOTE: Earlier model iPods may not be supported because they do not implement the USB control protocol. Also, the iPod shuffle is not supported because it does not utilize the 30-pin Apple iPod Connector. These unsupported iPod models may be connected to the radio using one of the Auxiliary Inputs.

Accessing iPod Mode

Connect a supported iPod or iPhone to the USB connector. The iPod icon illuminates in the bottom left corner of the LCD whenever an iPod or iPhone is attached to the USB connector. Music playback begins automatically.

To enter iPod mode from any other source, press the **MODE** button (4) until "LOADING" appears on the display. **If the user connects an iPod containing no files, the radio will display a message stating "No Songs" when it enters iPod mode.**

Turning the iPod On/Off

The iPod power turns on automatically when an iPod is connected to the USB connector, as long as the vehicle ignition is turned on. You can turn the iPod off by disconnecting it or by turning the ignition off. When the ignition is turned off, the iPod will pause and then enter sleep mode after 2 minutes. While the iPod is connected, the power cannot be turned on or off from the iPod itself.

NOTE: The iPod will continuously recharge while in iPod playback mode.

Controlling Playback



Selecting Tracks

During playback, press the **▶▶SEEK/TUNE/TRK /** button (14) to play the next track in the current category. Press the **◀◀SEEK/TUNE/TRK /** button (13) twice to play the previous track. **Press and hold the ◀◀SEEK/TUNE/TRK /** or **▶▶SEEK/TUNE/TRK /** buttons (13, 14) to fast reverse/forward the song.



Pausing Playback

During playback, press the **1▶||** button (5) to pause the iPod player. "Pause" will appear on the LCD. Press **1▶||** again to resume playback.

Repeat Play

During playback, press the **2 RPT /**  button (6) to repeat the current song. "Repeat One" will appear on the LCD. Press **2 RPT /**  again to stop repeat playback.

Random Play

During playback, press the **4 RDM /**  button (8) to play all songs in the current category in random order. Random play will begin once the current song has finished playing. "Random On" will appear on the LCD. Press **4 RDM /**  again to stop random playback.

NOTE: If you press and hold the **◀ SEEK/TUNE/TRK /** or **▶ SEEK/TUNE/TRK /** buttons to change the current song to the previous/next song, you will exit fast reverse/forward mode.

Alternate Display Information

Press the **DISP/SCROLL** button (12) to change the display information from single line default display to Artist/Song Title double line display mode.

Search Mode

Press the **BAND/SEARCH** button (16) to enter iPod search mode and choose from the following search criteria: Playlist, Artist, Album, Song, Genre, Composer, Audiobooks and Podcasts (consecutively).

When search mode is selected, press the **INFO/ENTER** button (18) to confirm selection. Use the **VOL+ UP / ▲** or **DOWN VOL- / ▼** buttons (2) to navigate through various list selections. Press **INFO/ENTER** (18) to make your final selection. Use the **AS/PS** button (15) to reverse navigate the list.

BLUETOOTH OPERATION

The unit includes built-in Bluetooth technology that allows you to wirelessly connect this head unit to Bluetooth devices for streaming audio playback.



About Bluetooth Technology

Bluetooth is a short-range wireless radio technology. Operating in the 2.4 GHz frequency range, it transmits voice and data at speeds up to 2.1 Mbit/s over a range of up to 10 meters.

Bluetooth Menu Options

NOTE: Please note that some Bluetooth menu options are only available while the unit is in Bluetooth Audio mode.

Press and hold the **AUDIO/MENU** button (3) to enter menu adjustment mode. Repeatedly press the **VOL+ UP / ▲** or **DOWN VOL- / ▼** buttons (2) to access the "Bluetooth On/Off" menu function. Press the **INFO/ENTER** button (18) to turn the Bluetooth function On or Off. The following menu options are available when the unit is in Bluetooth mode.

- Bluetooth Pair <ENTER>: Press the **INFO/ENTER** button to begin pairing with a Bluetooth enabled device in pairing mode.
- Bluetooth Device: Press the **INFO/ENTER** button to view a list of previously paired mobile phone device models. Press the **◀ SEEK/TUNE/TRK /** or **▶ SEEK/TUNE/TRK /** buttons (13, 14) to view devices from the list. You cannot delete a device that is actively connected. Press the **INFO/ENTER** button to select the device. Press the **◀ SEEK/TUNE/TRK /** or **▶ SEEK/TUNE/TRK /** buttons to choose Lock/Unlock, Disconnect or Delete for this device.
 - Lock/Unlock: The unit can store up to 5 devices for BT connection. The devices are stored in FIFO (First In First Out) order. To prevent a device from being bumped from the list when more than 5 devices are used, you must lock the device. To Lock/Unlock a device, press the **INFO/ENTER** button to display/change the Locked () or Unlocked () icon.
 - Disconnect: To disconnect a paired device, press the **INFO/ENTER** button to temporarily remove the BT link. The link can be re-established through your phone menu by selecting the unit for connection.
 - Delete: To delete a device from the list, press the **INFO/ENTER** button.

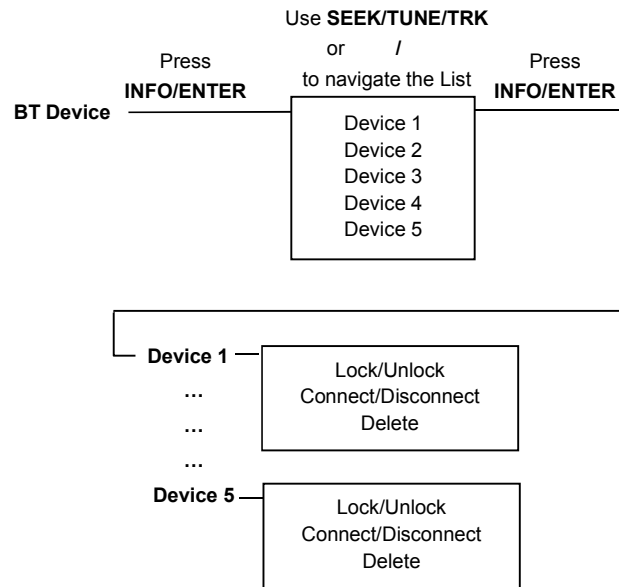

Pairing a Bluetooth Device

Before you begin, consult the owner's manual for the Bluetooth device you want to pair with the unit.

1. Make sure the device is on and ready to receive a signal from the unit. With the BT Audio mode, choose BT Pair from the menu and press the **INFO/ENTER** button to select ON. The unit is waiting to connect to a mobile device. With the Bluetooth function of the mobile device turned on, search for a Bluetooth device.
2. When the Bluetooth device has completed its search, the mobile device will display the Bluetooth device name.
3. Select the unit. The BT AUDIO icon (🎵) on the radio LCD will display.
4. Enter the pairing password (0000), if requested.

After connecting successfully, you are able to listen to music stored on your Bluetooth enabled device through the radio.

Answering a call

When answering a call using a connected phone, Bluetooth audio playback will pause. After hanging up from the call, Bluetooth audio playback will resume. On some phones it may be necessary to press the play button to resume playback.

Bluetooth Audio (A2DP)

The A2DP music is available for Bluetooth enabled phones when the phone is connected. To access Bluetooth mode and play songs stored on your phone, press the **MODE** button (4). While in BT mode (📶), the BT Audio icon (🎵) illuminates on the LCD.

Selecting Tracks

During playback, press the **◀SEEK/TUNE/TRK /** or **▶SEEK/TUNE/TRK /** button (13, 14) to play the previous or next track.

Pausing Playback

During playback, press the **1▶||** button (5) to pause the BT AUDIO player. "BT Audio Pause" will appear on the LCD. Press **1▶||** again to resume playback.

If you change to another mode, the mobile phone audio will pause. Press the **MODE** button (4) to return to BT mode and resume mobile phone audio playback.

NOTE: If a Bluetooth device is disconnected due to the power being turned off or if the device is disconnected inadvertently, the unit will automatically search for the matching Bluetooth device when the power is restored.

CARE AND MAINTENANCE

- Keep the product dry. If it does get wet, wipe it dry immediately. Liquids might contain minerals that can corrode the electronic circuits.
- Keep the product away from dust and dirt, which can cause premature wear of parts.
- Handle the product gently and carefully. Dropping it can damage circuit boards and cases, and can cause the product to work improperly.
- Wipe the product with a dampened cloth occasionally to keep it looking new. Do not use harsh chemicals, cleaning solvents, or strong detergents to clean the product.
- Use and store the product only in normal temperature environments. High temperature can shorten the life of electronic devices, damage batteries, and distort or melt plastic parts.

Ignition

The most common source of noise in reception is the ignition system. This is a result of the radio being placed close to the ignition system (engine). This type of noise can be easily detected because it will vary in intensity of pitch with the speed of the engine.

Usually, the ignition noise can be suppressed considerably by using a radio suppression type high voltage ignition wire and suppressor resistor in the ignition system. (Most vessels employ this wire and resistor but it may be necessary to check them for correct operation.) Another method of suppression is the use of additional noise suppressors. These can be obtained from most CB/A radio or electronic supply shops.

Interference

Radio reception in a moving environment is very different from reception in a stationary environment (home). It is very important to understand the difference.

AM reception will deteriorate when passing under a bridge or when passing under high voltage lines. Although AM is subject to environmental noise, it has the ability to be received at great distance. This is because broadcasting signals follow the curvature of the earth and are reflected back by the upper atmosphere.

TROUBLESHOOTING

| Symptom | Cause | Solution |
|---|--|---|
| No power | The vessel's accessory switch is not on | If the power supply is properly connected to the vessel's accessory terminal, switch the ignition key to "ACC". |
| | Fuse is blown | Replace the fuse. |
| No sound | Volume too slow | Adjust volume to audible level. |
| | Wiring is not properly connected | Check wiring connections. |
| The operation keys do not work | The built-in microprocessor is not operating properly due to noise | Press the reset button (19). |
| Cannot tune to radio station, auto-seek does not work | Antenna cable is not connected | Insert the antenna cable firmly. |
| | Signals are too weak. | Select a station manually. |

SPECIFICATIONS

FM Radio

| | |
|--|----------------------------------|
| Frequency Coverage (USA) | 87.5 to 107.9 MHz |
| Frequency Coverage (Europe, China, Latin, Australia) | 87.5 to 108 MHz |
| Frequency Coverage (Japan) | 76 to 90 MHz |
| Frequency Coverage (Russia) | 87.5 to 108 MHz and 65 to 74 MHz |
| Sensitivity (S/N=30dB) | 4 μ V |
| Image Rejection | >45 dB |
| Stereo Separation | >25 dB |

AM/MW

| | |
|--|-----------------|
| Frequency Range (USA, Latin) | 530 to 1710 kHz |
| Frequency Range (Europe, China, Japan, Russia) | 522 to 1620 kHz |
| Frequency Range (Australia) | 531 to 1629 kHz |
| Sensitivity (S/N=20dB) | 30 dB |

General

| | |
|---|---------------------------------|
| Frequency band(s) (for Bluetooth) | 2402-2480 MHz |
| Maximum radio-frequency power transmitted (for Bluetooth) | 5.64 dBm |
| Operating Voltage | DC 12 Volts |
| Grounding System | Negative Ground |
| Speaker Impedance | 4 - 8 Ω ohms per channel |
| Tone Controls: | |
| Bass (at 100 Hz) | \pm 14 dB |
| Treble (at 10 kHz) | \pm 13 dB |
| Power Output | 22 W x 4 |
| Fuse Rating | 15 Ampere (max.) |
| Chassis Dimensions | 182 (L) x 52.2 (W) x 173 (H) |
| Front Panel Dimensions | 188 (L) x 58 (W) x 21 (H) |



ASA Electronics Corporation

www.asaelectronics.com

@2017 ASA Electronics Corporation

V.120917